

### **PORTES ISOLÉES SÉRIE 5020**

Les portes isolées SÉRIE 5020 fabriquées par Alumico Architectural inc. seront en conformité avec les caractéristiques suivantes :

Les portes ont une épaisseur de **50,8mm (2")** et seront composées d'extrusions tubulaires de **127mm (5") pour les montants latéraux, de 127mm (5") pour la traverse du haut et 190,5mm (7 1/2") pour la traverse du bas**. Les coins auront des plaques de renforcement, des guides extrudés antitorsion avec joints à mortaise et des tiges de tension d'acier plaqué de 9,5mm (3/8") sur toute la largeur de la tête et de la base. Une barrière thermique en chlorure de polyvinyle rigide et son parement en aluminium extrudé seront fixé d'une manière non apparente sur la surface intérieure de la porte. Les parclozes seront de type à enclenchement. Une extrusion de néoprène sera insérée dans la parclose pour permettre un vitrage à sec.

Toutes les composantes d'aluminium seront faites de l'alliage 6063 de la trempe T5.

#### **Finis**

Toutes les surfaces exposées seront traitées selon les options suivantes:

a) Traitement anodique:

- Naturel n°100: conforme à AA-M12C22A31 (classe 2) / 41 (classe 1)
- Champagne n°101: conforme à AA-M12C22A44
- Bronze pâle n°103: conforme à AA-M12C22A44
- Bronze arch. n°106: conforme à AA-M12C22A44
- Noir n°109: conforme à AA-M12C22A44

b) Peinture:

L'aluminium subira un prétraitement et sera recouvert d'un fini à la poudre, rencontrant les normes suivantes:

- AAMA 2603
- AAMA 2604
- AAMA 2605

#### **Installation**

Toutes les portes devront être installées par des techniciens qualifiés. Ceux-ci devront d'abord s'assurer que les ouvertures auront été préparées convenablement d'aplomb, d'équerre et de niveau. Tout le travail devra être exécuté en harmonie avec les travaux adjacents.

#### **Garantie**

Les portes isolées SÉRIE 5020 seront couvertes par une garantie de base du manufacturier contre tout défaut des matériaux pour une période de un an à partir de l'acceptation des travaux.

### **5020 SERIES INSOLATED DOORS**

5020 SERIES thermally broken doors manufactured by Alumico Architectural inc. will be in accordance with the following specifications:

Doors will have a **thickness of 50,8mm (2")** and will be composed of tubular extrusions with **127mm (5") stiles, 127mm (5") top rail and 190,5mm (7 1/2") bottom rail**. Corners will have reinforcing plates, extruded anti-torsion guides with mortise joints and 9,5mm (3/8") plated steel tension rods across the width of the top and the bottom rails. A rigid PVC thermal barrier covered with an extruded aluminum cladding shall both be fixed to the inside face of the door with concealed fasteners. The glass stop will be an integral sash with a neoprene bulb insert for dry glazing.

All aluminum components will be made of 6063 alloy with T5 temper.

#### **Finishes**

All exposed surfaces will be coated with one of the following options:

a) Anodizing:

- Clear #100: as per AA-M12C22A31 (class 2) / 41 (class 1)
- Champagne #101: as per AA-M12C22A44
- Light bronze #103: as per AA-M12C22A44
- Arch. bronze #106: as per AA-M12C22A44
- Dark bronze #107: as per AA-M12C22A44
- Black #109: as per AA-M12C22A44

b) Paint:

Aluminum will undergo a pretreatment and be covered with a powder finish, and will meet the following specifications:

- AAMA 2603
- AAMA 2604
- AAMA 2605

#### **Installation**

All doors shall be installed by experienced technicians in correctly prepared openings. They shall be set plumb, square and level in correct alignment with other work and will be ready for operation.

#### **Warranty**

5020 SERIES insulated door components will be covered by a basic warranty from the manufacturer against defective materials for a one year period upon acceptance of work.

## ASSEMBLAGE TYPIQUE TYPICAL ASSEMBLY

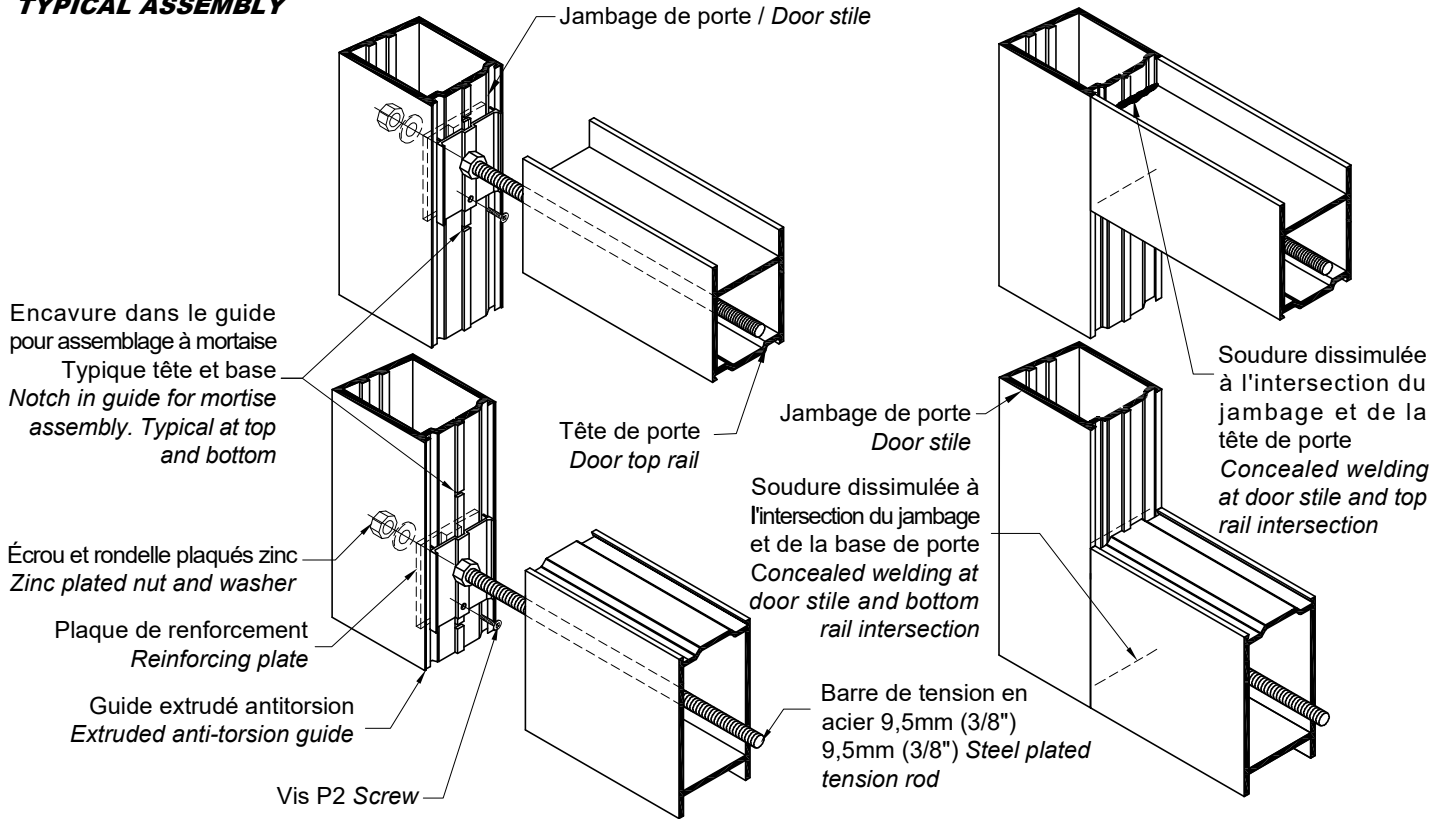

Dimensions maximales Maximum Dimensions	
Largeur Width	1219mm 48"
Hauteur Height	3048mm 120"

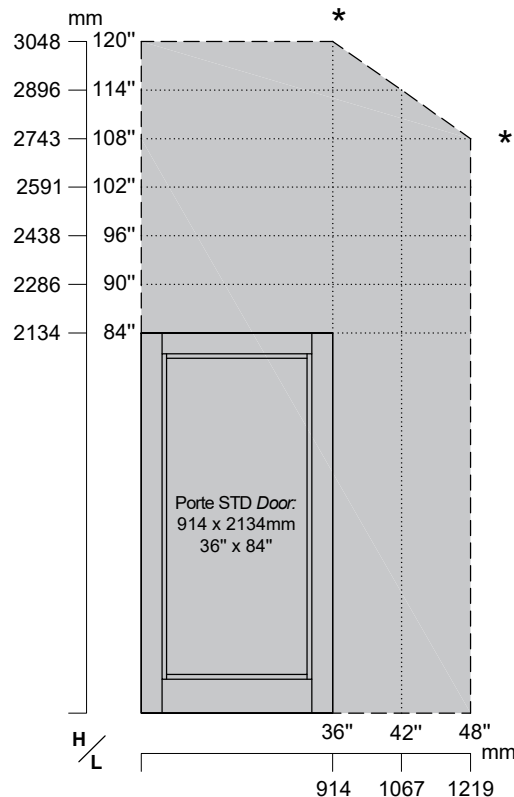

\* Communiquez avec nous pour d'autres dimensions  
Contact us for other dimensions

## SENS D'OUVERTURE DOOR SWING

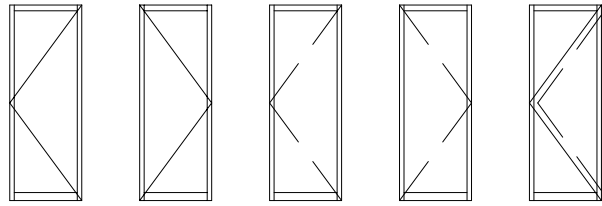

**GE / LHO** Main gauche ext. Left hand out  
**DE / RHO** Main droite ext. Right hand out  
**GI / LHI** Main gauche int. Left hand in  
**DI / RHI** Main droite int. Right hand in  
**GDA / LHDA** Main gauche double action Left hand double acting

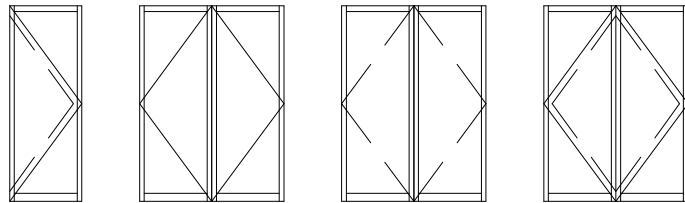

**DDA / RHDA** Main droite double action Right hand double acting  
**PE** Paire extérieure Exterior pair  
**PI** Paire intérieure Interior pair  
**PDA** Paire double action Double acting pair

## ÉQUERRAGE SQUARING

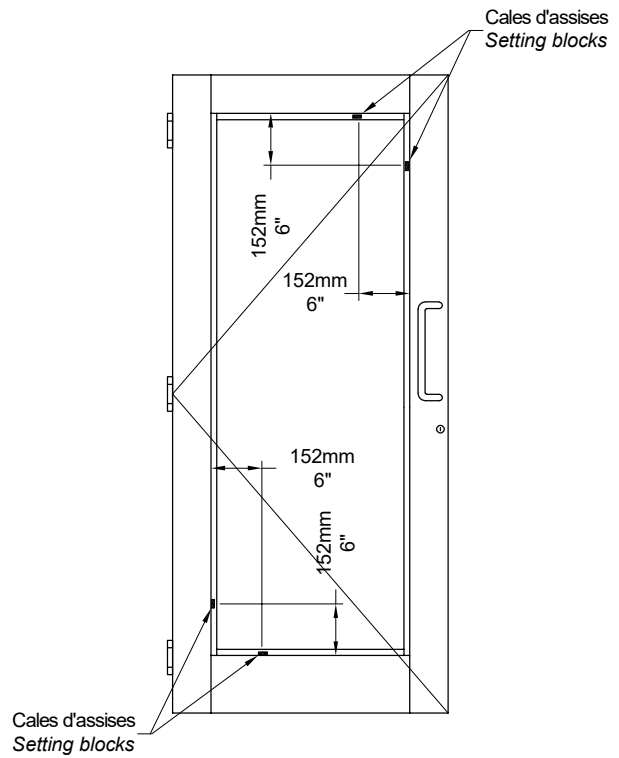

## Épaisseur de vitrage Glazing Thickness

Parcloses AGA129  
 Double garnitures V1064  
 AGA129 Glass stop  
 Double V1064 Glazing spline

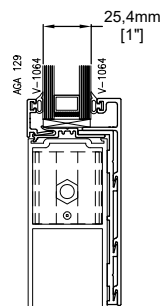

## Dimensions de vitrage Glass Sizes

Configuration hors STD STD free configuration	Ouv. / O.S -23,6mm (15/16")
Porte simple / Single door 914mm x 2134mm (36" x 84")	635mm x 1775mm 25" x 69 7/8"
Paire de portes / Pair of doors 1829mm x 2134mm (72" x 84")	

## ÉLÉVATION DE PORTE STANDARD STANDARD DOOR ELEVATION

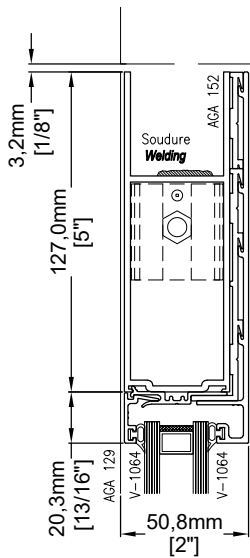
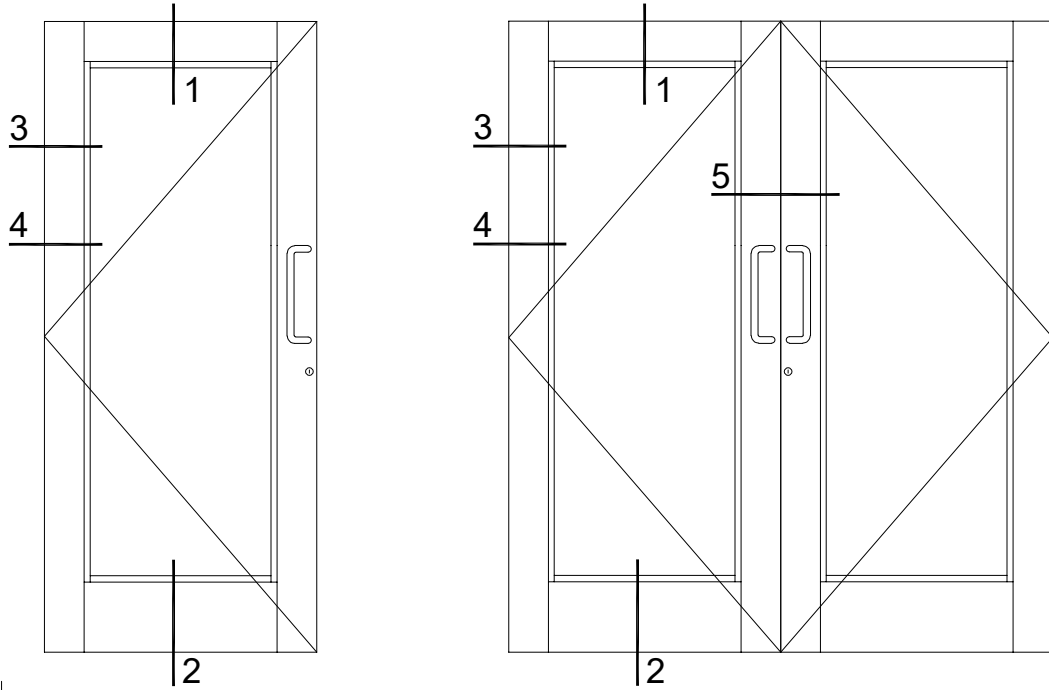

①

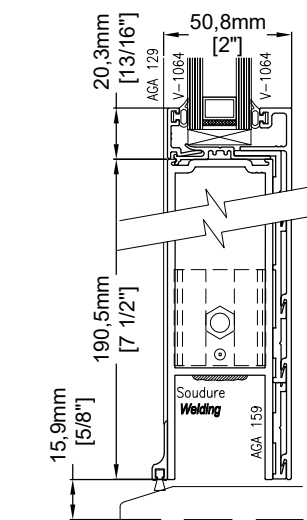

②

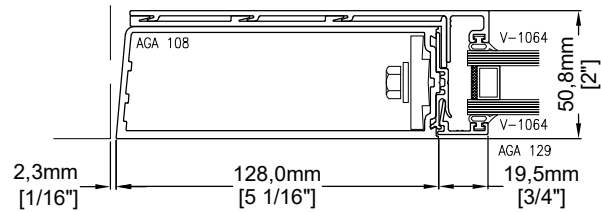

③

**Charnière à roulement à bille**  
**Five knuckles hinge**

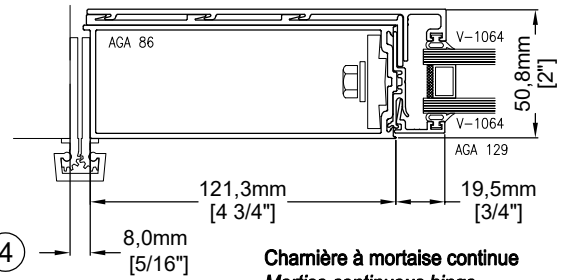

④

**Charnière à mortaise continue**  
**Mortise continuous hinge**

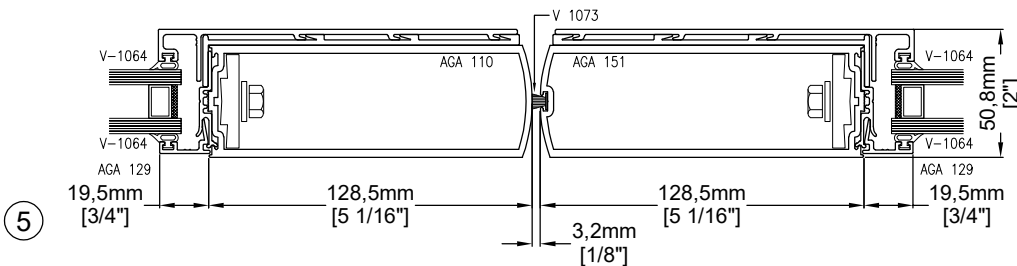

⑤

Options : Bases et Têtes / *Bottom and Top rails*

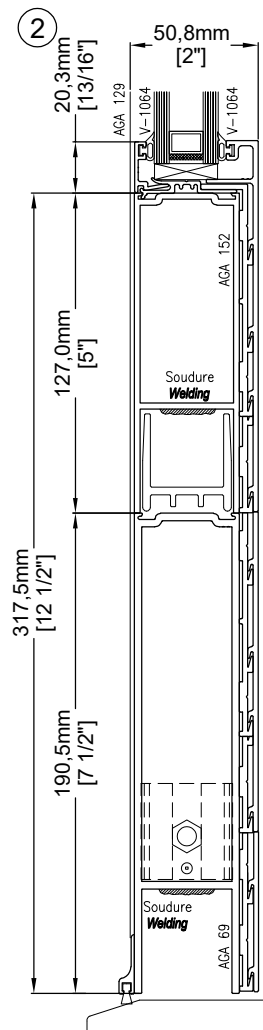
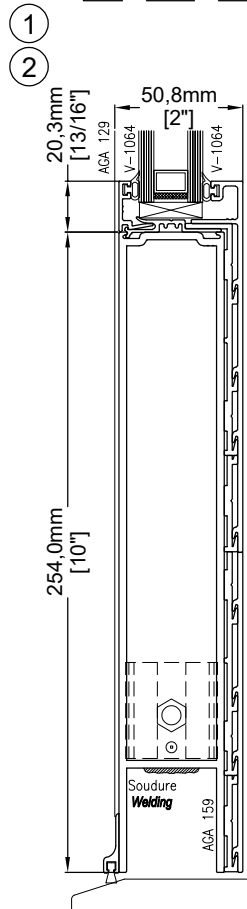
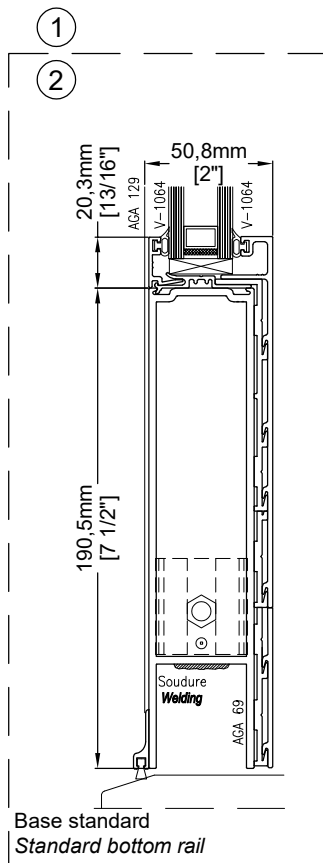
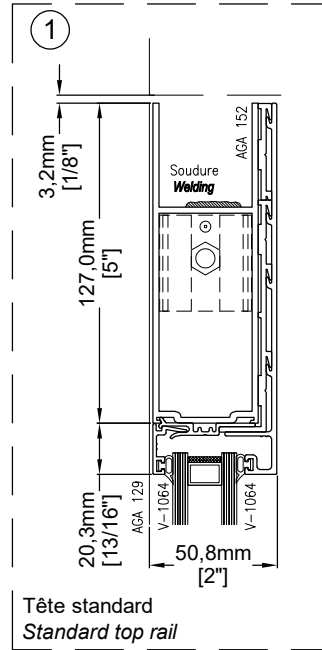
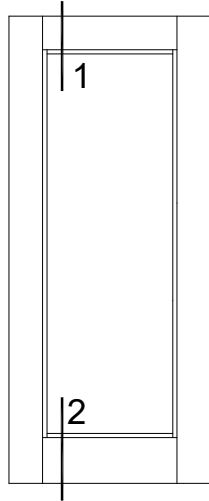



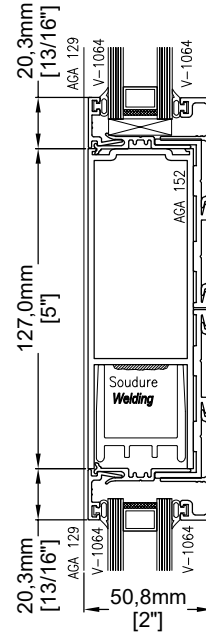
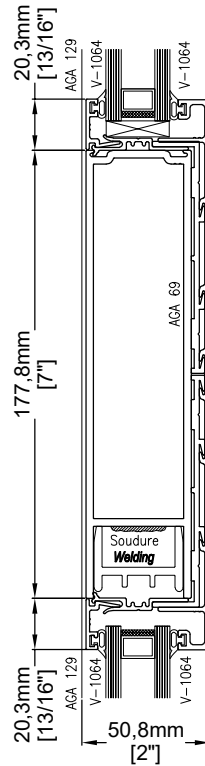
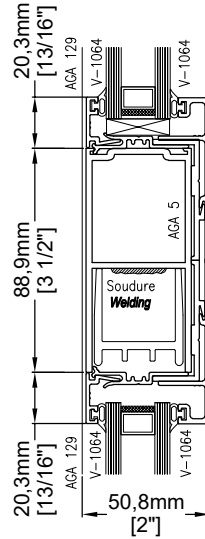
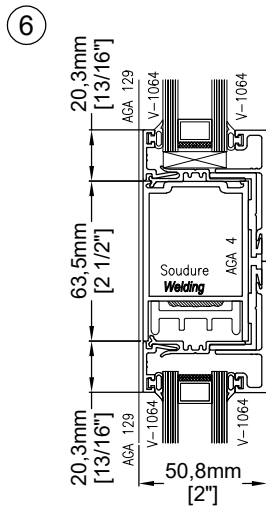
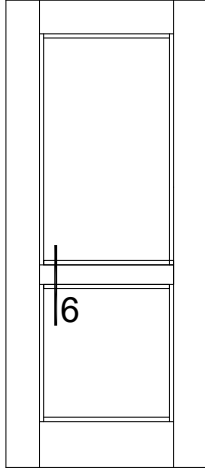

Options : Traverses / Mid rails

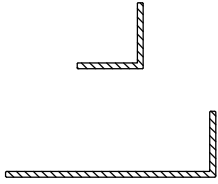
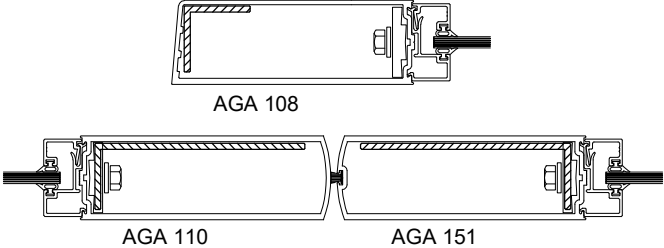

## Options : Renforts / Reinforcements

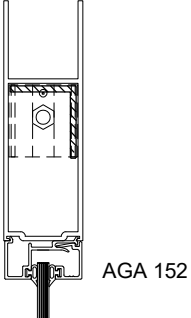
Note: Renforts disponibles en acier prépeint, acier galvanisé ou en aluminium  
*Available reinforcement in prepainted steel, galvanized steel or aluminum*

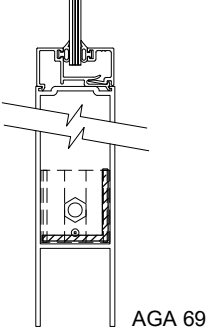
<p>Renfort pour montants latéraux <i>Reinforcement for stile</i></p> <p><u>Dimensions:</u> 36,5 x 36,5 x 3,2mm (1 <math>\frac{3}{8}</math>" x 1 <math>\frac{3}{8}</math>" x <math>\frac{1}{8}</math>" )</p> <p>34,9 x 111,2 x 3,2mm (1 <math>\frac{3}{8}</math>" x 4 <math>\frac{3}{8}</math>" x <math>\frac{1}{8}</math>" )</p>		
<p>Renfort pour traverse du haut <i>Reinforcement for top rail</i></p> <p><u>Dimensions:</u> 34,9 x 38,1 x 3,2mm (1 <math>\frac{3}{8}</math>" x 1 <math>\frac{1}{2}</math>" x <math>\frac{1}{8}</math>" )</p>		
<p>Renfort pour traverse du bas <i>Reinforcement for bottom rail</i></p> <p><u>Dimensions:</u> 34,9 x 38,1 x 3,2mm (1 <math>\frac{3}{8}</math>" x 1 <math>\frac{1}{2}</math>" x <math>\frac{1}{8}</math>" )</p>		

## POSITIONS STANDARDS DE QUINCAILLERIE STANDARD HARDWARE LOCATIONS

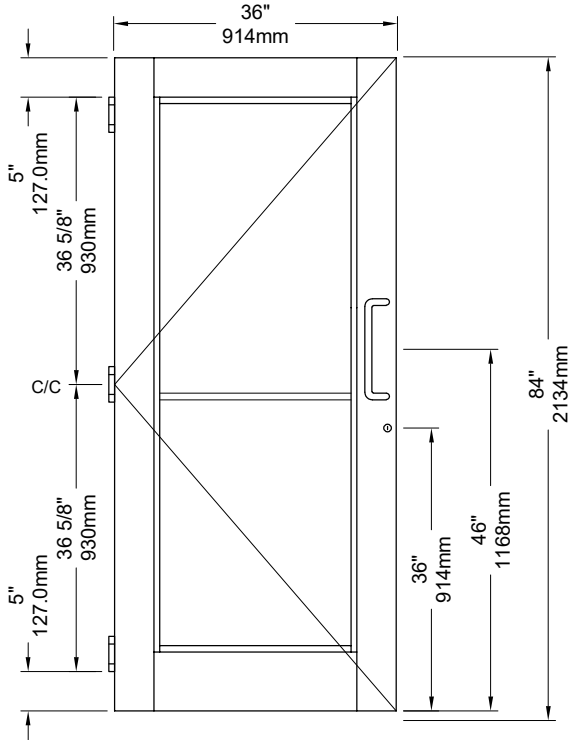

Poignée à tirer AR2000	<i>Pull Handle AR2000</i>
Barre à pousser AR5000	<i>Push Bar AR5000</i>
Charnières H7	<i>Hinges H7</i>
Serrure MS H18	<i>MS Dead Lock H18</i>

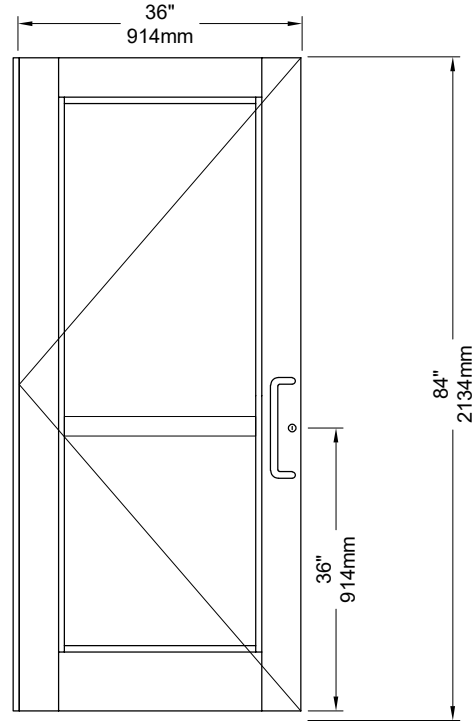



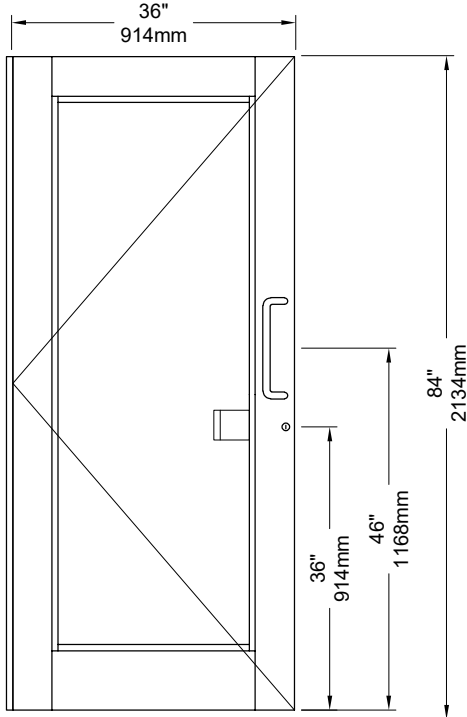



Poignée à tirer AR2000	<i>Pull Handle AR2000</i>
Barre panique H34	<i>Exit Device H34</i>
Charnière continue H81	<i>Continuous Hinge H81</i>
Serrure à verrou H19	<i>Dead Latch H19</i>



Poignée à tirer AR2000	<i>Pull Handle AR2000</i>
Palette de relâche H20	<i>Release Handle H20</i>
Charnière continue H81	<i>Continuous Hinge H81</i>
Serrure à verrou H19	<i>Dead Latch H19</i>







### Standard : Quincaillerie / Hardware

	Description	Numéro de pièce Part number	Note
	Poignée à tirer tubulaire standard 305mm x 25mm diamètre <i>Standard Tubular pull handle 12" x 1" diameter</i> Standard : 12" (304,8mm) Options : 9" (228,6mm) 16" (406,4mm) 20" (508mm)	AR2000	Simple ou dos à dos <i>Single or back to back</i> Disponible sur demande: <b>Available upon request:</b> Acier inoxydable <i>Stainless steel</i>
	Charnière plaquée nickel, satinée ou émaillée 4 1/2" x 4" (114 x 102mm) <i>Satin nickel plated or baked enamel hinge</i> -100 - gris / grey -106 - bronze / bronze	H7	
	Plaque de support 3/16" (4,8mm) pour charnière 3/16" (4,8mm) Hinge back up plate	H10	
	Serrure à sécurité maximum retrait barillet 1 1/8" <i>Maximum security dead lock 1 1/8" cylinder back set</i>	H18	
	Plaque de garniture pour serrure H18 <i>Face plate for H18 lock</i>  *Spécifier si GE, DE ou PE <i>Specify if LHO, RHO or PE</i>	H13R H13L H13P	Droite / <i>Right</i> Gauche / <i>Left</i> Paire / <i>Pair</i>
	Barrilet mortaisé régulier avec deux clés <i>Standard mortised cylinder with two keys</i> -100 - gris / grey -106 - bronze / bronze	H22	



### Standard : Seuils / Threshold

	Seuil isolé biseauté 2 côtés 6" (152mm) <i>Thermally broken threshold bevelled 2 sides</i>	S11	
---	--	-----	--

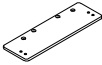
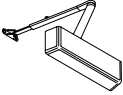
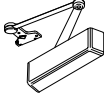



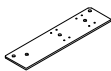

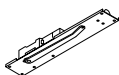
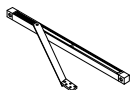
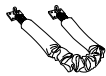
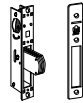

### Options : Quincaillerie / Hardware

	Description	Numéro de pièce Part number	Note
	<p>Poignée à tirer tubulaire 305mm x 25mm diamètre Tubular pull handle 12" x 1" diameter</p> <p>Standard : 12" (304,8mm) Options : 9" (228,6mm) 16" (406,4mm) 20" (508mm)</p>	AR1000	<p>Simple ou dos à dos <i>Single or back to back</i></p> <p>Disponible sur demande: Available upon request: Acier inoxydable <i>Stainless steel</i></p>
	<p>Barre à pousser tubulaire 25mm diamètre <i>Tubular push bar 1" diameter</i></p>	AR5000	<p>Disponible sur demande: Available upon request: Acier inoxydable <i>Stainless steel</i></p>
	<p>Ferme porte en surface robuste <i>Heavy duty surface door closer</i></p>	H55	
	<p>Ferme porte en surface robuste avec bras de retenue <i>Heavy duty surface door closer with hold open arm</i></p>	H56	
	<p>Plaque de support pour H55 et H56 <i>Drop plate for H55 and H56</i></p>	H57	<p>Pour ferme-porte H55 et H56 <i>For door closer H54, H55 and H56</i></p>
	<p>Ferme porte extra-robuste en surface LCN4040 avec bras régulier <i>Surface heavy-duty door closer LCN4040 with regular arm</i></p>	H59	<p>Force : 2 à/to 6</p> <p>Compatible avec tête 3 1/2" minimum et plus grand <i>Compatible with a 3 1/2" minimum top rail</i></p>
	<p>Ferme porte extra-robuste en surface LCN4040 avec bras d'arrêt "Cush and Stop"</p> <p><i>Surface heavy-duty door closer LCN4040 with "Cush and Stop" arm</i></p>	H59A	<p>Force : 2 à/to 6</p> <p>Compatible avec tête 3 1/2" minimum et plus grand <i>Compatible with a 3 1/2" minimum top rail</i></p>









### Options : Quincaillerie / Hardware

	Description	Numéro de pièce Part number	Note
	Plaque de support pour H59 et H59A <i>Drop plate for H59 and H59A</i>	H60	Ferme porte sur la porte avec H59 <i>Door closer on door with H59</i>
		H60G	Cadre avec imposte avec H59 <i>Frame with transom with H59</i>
		H60J	Cadre sans imposte avec H59 <i>Frame without transom with H59</i>
		H60PA	Pour bras Cush-n-Stop avec H59 <i>For Cush-n-Stop arm with H59</i>
	Ferme porte encastré 20-330 jackson <i>Concealed overhead closer 20-330 jackson</i>  *Spécifier 90° ou 105° / <i>Specify 90° or 105°</i> *S'utilise avec pivots centrés / <i>Use with center pivots</i>	H88	Compatible avec sens d'ouverture GDA, DDA et PDA <i>Compatible with door swing LHDA, RHDA and PDA</i>
	Ferme porte encastré serie LCN2030 <i>Concealed hydraulic door closer LCN 2030 series</i> *Spécifier 90° ou 105° / <i>Specify 90° or 105°</i> **S'utilise avec charnières ou pivots décentrés <i>Use with hinge or offset pivots</i> ***Spécifier GE ou DE <i>Specify LHO or RHO</i>	H50	
	Bras d'arrêt et de retenue de surface Glynn-Johnson pour porte de 813mm @ 1067mm  <i>Surface door holder and stopper arm for door of 32" to 42"</i>	H12 H12A	Encastré <i>Recessed</i>
	Chaîne tempête <i>Storm chain</i>	H40A H40B	25 1/2" (648mm) 30 1/2" (775mm)
	Serrure à sécurité maximum pêne court retrait barillet 1 1/8" <i>Short bolt maximum security lock 1 1/8" cylinder back set</i>	H18B	





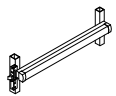
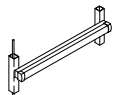
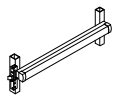

### Options : Quincaillerie / Hardware

	Serrure à verrou (retrait barillet 1 1/8") <i>Dead latch (cylinder backset 1 1/8")</i>	H19	Retrait de barillet / <i>Cylinder back set:</i> 1 1/8" (29 mm)
	Serrure à verrou (retrait barillet 31/32") <i>Dead latch (cylinder backset 31/32")</i>	H19A	Retrait de barillet / <i>Cylinder back set:</i> 31/32"
	Serrure à verrou robuste (retrait barillet 1 1/8") <i>Heavy duty dead latch (cylinder backset 1 1/8")</i>	H19H	
	Plaqué de garniture pour serrure H19 <i>Face plate for H19 lock</i>	H14R	Droite / <i>Right</i>
		H14L	Gauche / <i>Left</i>
	*Spécifier si GE, DE ou PE <i>Specify if LHO, RHO or PE</i>	H14P	Paire / <i>Pair</i>
	Contacteur électrique pour paire de portes <i>Electric connectors for doors pair</i>	H21B	
		H21C	
	Gâche électrique 16-24 volts PESO <i>16-24 volts electric strike PESO</i>	H21	
	Gâche électrique 24 volts <i>24 volts electric strike</i> 7100 ADAMS RITE 7400 ADAMS RITE	H21A H21G	
	Gâche électrique HES <i>HES electric strike</i>	H21H	Mur-rideau 6175HP Curtain Wall
	Pêne à rouleau avec gâche en acier <i>Roller Latch with steel strike</i>	H46	
	Gâche standard en acier inoxydable pour serrure à verrou H19 <i>Stainless steel strike for dead latch H19</i>	H19B	
	Barillet mortaisé court avec deux clés <i>Short mortise cylinder with two keys</i>  -100 - gris / <i>grey</i> -106 - bronze / <i>bronze</i>	H23A	
	Barrillet manuel <i>Thumbturn mortised cylinder</i>  -100 - gris / <i>grey</i> -106 - bronze / <i>bronze</i>	H24	

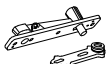
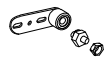
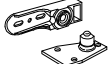

## Options : Quincaillerie / Hardware

	Description	Numéro de pièce Part number	Note
	Faux barillet mortaisé <i>Dummy mortised cylinder</i> -100 - gris / grey -106 - bronze / bronze	H24A	
	Anneau de sécurité <i>Cylinder guard</i> -100 - gris / grey	H22A	
	Anneau de sécurité robuste <i>Heavy-duty cylinder guard</i> -100 - gris / grey	H22B	
	Plaque de protection <i>Security plate</i>  *Spécifier GE ou DE (H90L ou H90R) <i>Specify LHO or RHO (H90L or H90R)</i>	H90	
	Verrou effleuré <i>Flush bolt</i> -100 - gris / grey -106 - bronze / bronze	H25	
	Poignée de relâche <i>Release handle</i>  *Spécifier GE ou DE (H20AL ou H20R) <i>Specify LHO or RHO (H20AL or H20AR)</i>	H20A	Seulement pour pousser <i>For Push only</i>
	Palette de relâche Adams Rite <i>Adams Rite Push paddle</i>  *Spécifier GE ou DE (H20L ou H20R) <i>Specify LHO or RHO (H20L or H20R)</i>	H20	Seulement pour pousser <i>For Push only</i>
	Barre panique Adams Rite à mortaise (pour porte 1 3/4") <i>Mortised type Adams Rite exit device (For 1 3/4" depth door)</i> Largeur maximum porte 42" / <i>Maximum door width 42"</i> *Spécifier GE ou DE / <i>Specify LHO or RHO</i>	H34	
	Barre panique à tige encastrée Adams Rite <i>Concealed rod exit device</i> Largeur maximum porte 36" / <i>hauteur maximum porte 96"</i> Maximum door width 36" / <i>Maximum door width 96"</i>	H34A	
	Barre panique Dorex à mortaise (Pour porte 1 3/4" d'épaisseur) <i>Mortised type Dorex exit device (For 1 3/4" depth door)</i> Largeur maximum porte 42" / <i>Maximum door width 42"</i> *Spécifier GE ou DE / <i>Specify LHO or RHO</i>	H38	
	Plaque de montage pour barre panique H34A <i>Cylinder mounting pad for H34A panic exit device</i> -100 - gris / grey -106 - bronze / bronze	H22D	

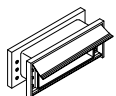

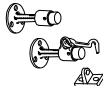

### Options : Quincaillerie / Hardware

	Description	Numéro de pièce Part number	Note
	Ensemble de pivots centrés haut et bas <i>Top and bottom center pivots</i>	H5	
	Pivot centré du bas avec seuil <i>Center hung bottom pivot with treshold</i>		
	Pivot centré du bas sans seuil <i>Center hung bottom pivot without treshold</i>	H5A	
	Charnières en acier inoxydable <i>Stainless steel hinge</i> 4 1/2" x 4" (114 x 102mm)	H8	Finis / <i>Finish:</i> Acier inoxydable <i>Stainless steel</i>
	Charnière continue HD pour porte <i>Continuous HD hinge</i>	H81 H82 H82B	84" (2134 mm) 96" (2438 mm) 120" (3048mm)
	Charnière continue en surface <i>Continuous surface hinge</i>	H83 H84	84" (2134 mm) 96" (2438 mm)
	Astragale pour porte avec V1075 <i>Astragal for door with V1075</i>	H520	84" (2133,6 mm) 96" (2438,4 mm) 120" (3048mm)
	Coupe froid bas de porte avec mohair V1079, 2500' <i>Bottom door weather strip with V1079 mohair, 2500'</i>	H41 H41A	36" (914,4 mm) 42" (1066,8 mm)
	Passe courrier isolé <i>Thermally broken letter slot 3 1/2" (88.9mm)</i>	H39	Compatible avec traverse AGA5 et plus grand <i>Compatible with AGA5 mid rail and greather</i>

### Options : Quincaillerie / Hardware

	Description	Numéro de pièce Part number	Note
	Butoir de porte rabattable <i>Flip down door stop</i>	H31	
	Butoir de porte mural <i>Wall mounted door stop</i>	H31A  H31AC	Régulier <i>Regular</i>  Avec crochet <i>With hook</i>
	Butoir de porte plancher <i>Floor door stop</i>	H32  H32C	Régulier <i>Regular</i>  Avec crochet <i>With hook</i>

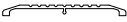
### Options : Seuils / Thresholds

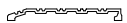
	Arrêt de porte au seuil <i>Door stop at threshold</i>	S2	
	Seuil biseauté 2 côtés 4" (101.6mm) <i>Threshold bevelled 2 sides</i>	S4	
	Seuil biseauté 2 côtés 6" (152mm) <i>Threshold bevelled 2 sides</i>	S6	
	Seuil biseauté 2 côtés 8" (203mm) <i>Threshold bevelled 2 sides</i>	S8	
	Seuil biseauté 1 côté 5" (127mm) <i>Threshold bevelled 1 side</i>	S10	