

PORTES COULISSANTES SÉRIE 3000

Les portes coulissantes SÉRIE 3000 fabriquées par Alumico Architectural inc. seront en conformité avec les caractéristiques suivantes :

Les portes auront une épaisseur de **44,5mm (1 3/4")** et seront composées d'extrusions tubulaires de **50,8mm (2")** pour les montants latéraux, de **63,5mm (2 1/2")** pour la traverse du haut et de **88,9mm (3 1/2")** pour la traverse du bas. Les parclozes seront de type à enclenchement, qui ne pourront être enlevées de l'extérieur. Une extrusion de néoprène sera insérée dans la parcloze pour permettre un vitrage à sec.

Toutes les composantes d'aluminium seront faites de l'alliage 6063 de la trempe T5.

Finis

Toutes les surfaces exposées seront traitées selon les options suivantes:

a) Traitement anodique:

- Naturel n°100: conforme à AA-M12C22A31 (classe 2) / 41 (classe 1)
- Champagne n°101: conforme à AA-M12C22A44
- Bronze pâle n°103: conforme à AA-M12C22A44
- Bronze arch. n°106: conforme à AA-M12C22A44
- Noir n°109: conforme à AA-M12C22A44

b) Peinture:

L'aluminium subira un prétraitement étapes et sera recouvert d'un fini à la poudre rencontrant les normes suivantes:

- AAMA 2603
- AAMA 2604
- AAMA 2605

Installation

Toutes les portes coulissantes devront être installées par des techniciens qualifiés. Ceux-ci devront d'abord s'assurer que les ouvertures auront été préparées convenablement d'aplomb, d'équerre et de niveau. Tout le travail devra être exécuté en harmonie avec les travaux adjacents.

Garantie

Les portes coulissantes SÉRIE 3000 seront couvertes par une garantie de base du manufacturier contre tout défaut des matériaux pour une période de un an à partir de l'acceptation des travaux.

3000 SERIES SLIDING DOORS

3000 SERIES sliding doors manufactured by Alumico Architectural inc. will be in accordance with the following specifications:

Doors will have a **thickness of 44,5mm (1 3/4")** and will be composed of tubular extrusions with **50,8mm (2") stiles, 63,5mm (2 1/2") top rail and 88,9mm (3 1/2") bottom rail**. The glass stop will be an integral sash that can not be removed from the exterior, with a neoprene bulb insert for dry glazing.

All aluminum components will be made of 6063 alloy with T5 temper.

Finishes

All exposed surfaces will be coated with one of the following options:

a) Anodizing:

- Clear #100: as per AA-M12C22A31 (class 2) / 41 (class 1)
- Champagne #101: as per AA-M12C22A44
- Light bronze #103: as per AA-M12C22A44
- Arch. bronze #106: as per AA-M12C22A44
- Black #109: as per AA-M12C22A44

b) Paint:

Aluminum will undergo a pretreatment and be covered with a powder finish, and will meet the following specifications:

- AAMA 2603
- AAMA 2604
- AAMA 2605





Installation

All sliding doors shall be installed by experienced technicians in correctly prepared openings. They shall be set plumb, square and level in correct alignment with other work and shall be ready for operation.







Warranty

3000 SERIES insulated door components will be covered by a basic warranty from the manufacturer against defective materials for a one year period upon acceptance of work.

Éléments de Cadre / Frame Components

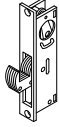
	Description	Numéro de pièce <i>Part number</i>	Longueur standard <i>Standard length</i>
	Jambage <i>Jamb</i>	3001	6,7 mètres / <i>meters</i> 22 pieds / <i>feet</i>
	Crochet mural incluant coupe froid <i>Wall hook with weather strip</i>	3002	6,7 mètres / <i>meters</i> 22 pieds / <i>feet</i>
	Rail du haut 1 3/4" (44.5mm) Incluant coupe froid <i>1 3/4" (44.5mm) Top track with weather strip</i>	3003	6,7 mètres / <i>meters</i> 22 pieds / <i>feet</i>
	Rail du bas 1/2" (12.7mm) Fini du moulin <i>1/2" (12.7mm) Bottom track Mill finish</i>	3004	6,7 mètres / <i>meters</i> 22 pieds / <i>feet</i>
	Coupe froid rail du haut <i>Weather strip for top track</i>	V1072	610 mètres / <i>rouleau</i> 2000 feet / <i>roll</i>

Quincaillerie / Hardware

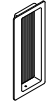
	Description	Numéro de pièce <i>Part number</i>	Longueur standard <i>Standard length</i>
	Coupe froid pour battant de porte <i>Weather strip for door stile</i>	V1073	457 mètres / <i>rouleau</i> 1500 feet / <i>roll</i>
	Mécanisme de roulement <i>Roller assembly</i>	H11	
	Serrure à crochet <i>Hook bolt lock</i>	H17	
	Anneau de sécurité <i>Cylinder guard</i> -100 - gris / <i>grey</i>	H22A	
	Barillet mortaisé court avec deux clés <i>Short mortise cylinder with two keys</i> -100 - gris / <i>grey</i> -106 - bronze / <i>bronze</i>	H23A	
	Barillet manuel mortaisé <i>Thumbturn mortised cylinder</i> -100 - gris / <i>grey</i> -106 - bronze / <i>bronze</i>	H24	
	Poignée de porte coulissante série 3000 <i>Sliding door handle 3000 series</i>	H44	

ASSEMBLAGE TYPIQUE TYPICAL ASSEMBLY

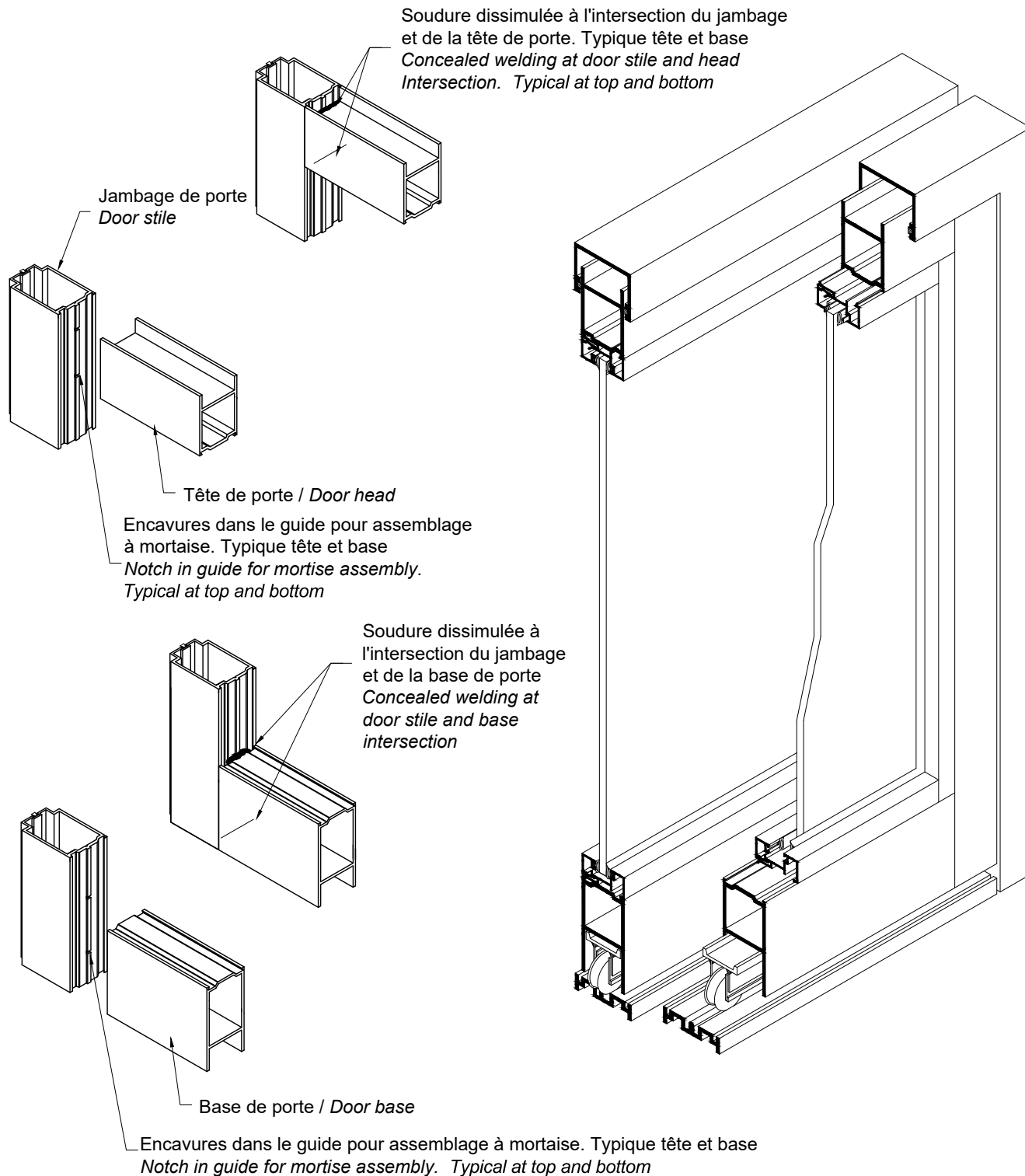

ÉLÉVATION DE PORTE STANDARD STANDARD DOOR ELEVATION

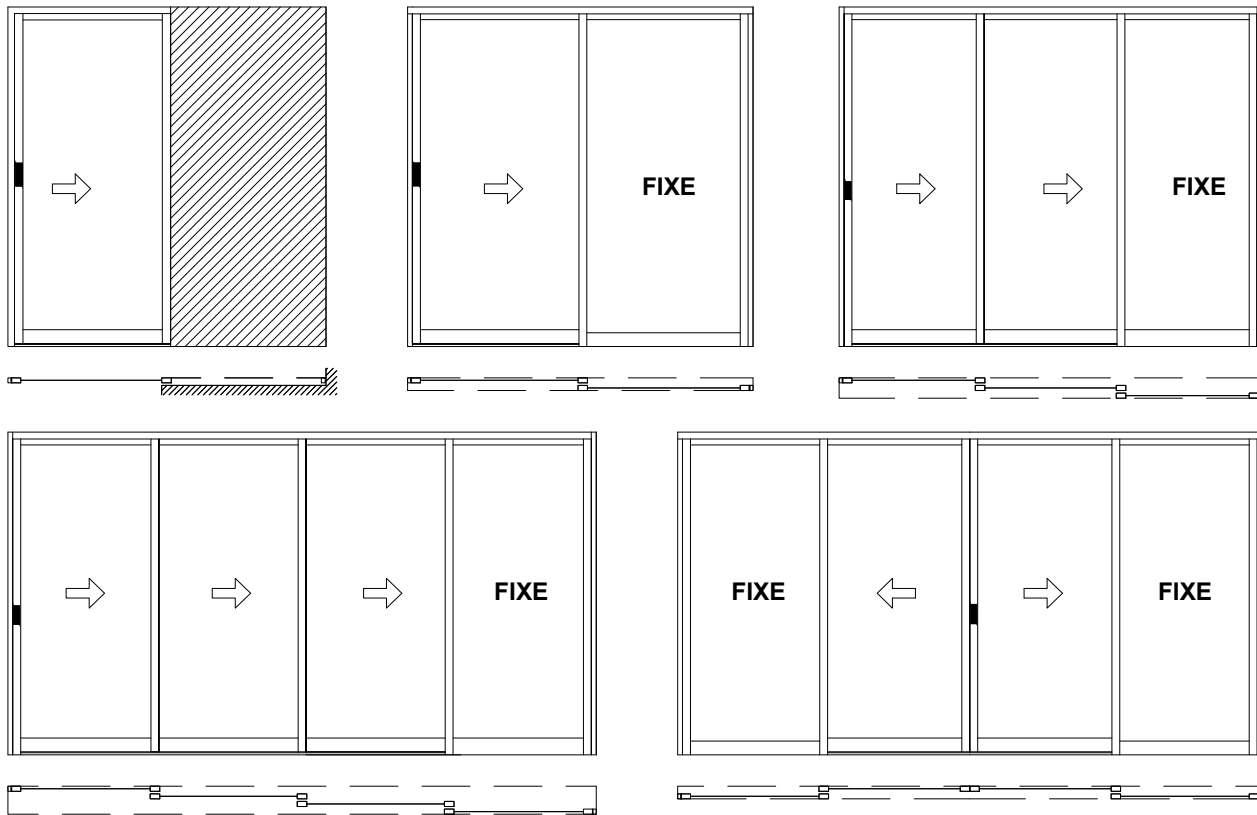

Dimensions maximales Maximum Dimensions	
Largeur Width	2134mm 84"
Hauteur Height	2540mm 100"

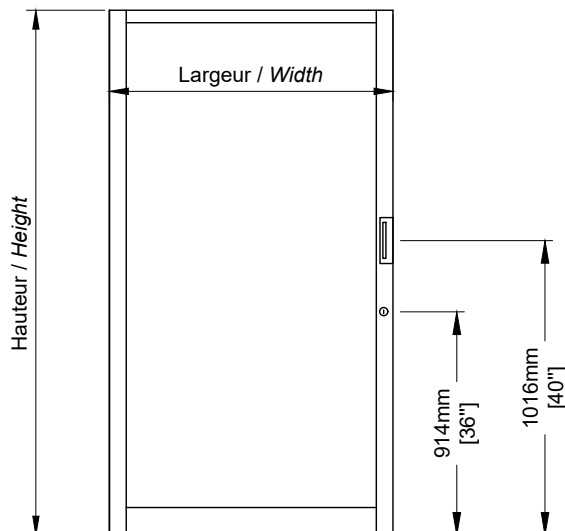

Épaisseurs de vitrage Glazing Thickness

Parclose AGA113 et AGA114
Doubles garnitures V1064
AGA113 and AGA114 Glass stop
Double V1064 Glazing spline

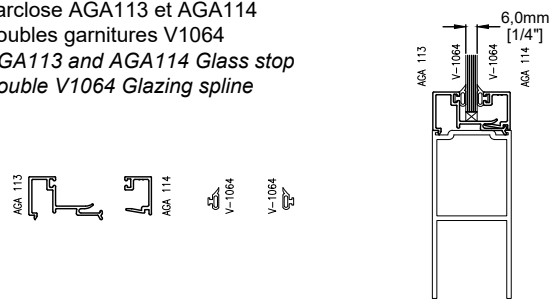

Parclose AGA130 et AGA129
Doubles garnitures V1064
AGA130 and AGA129 Glass stop
Double V1064 Glazing spline

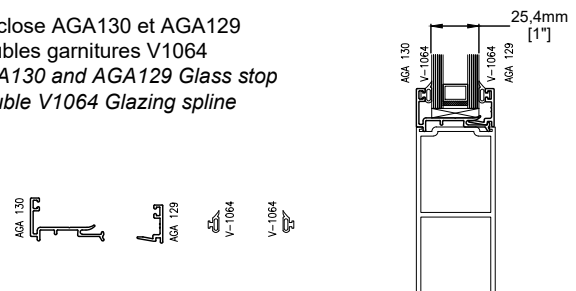

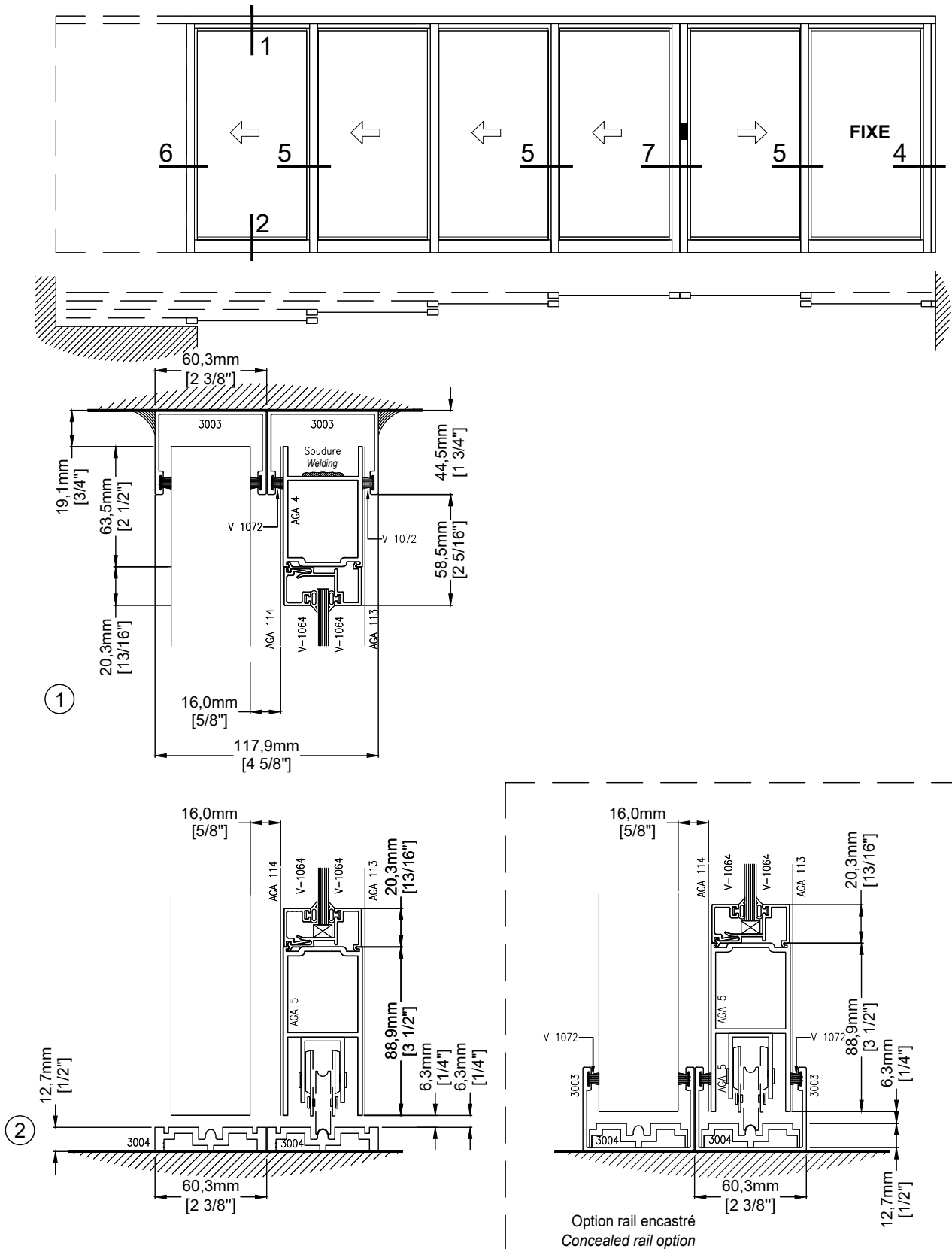

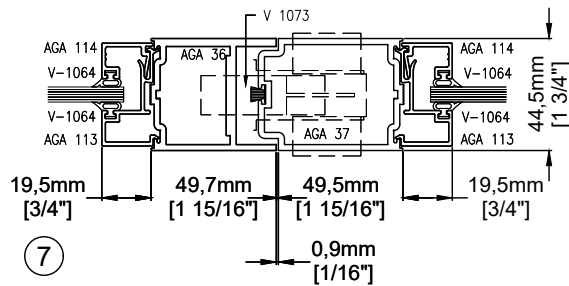
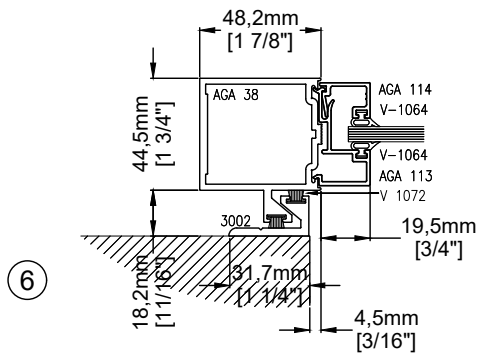
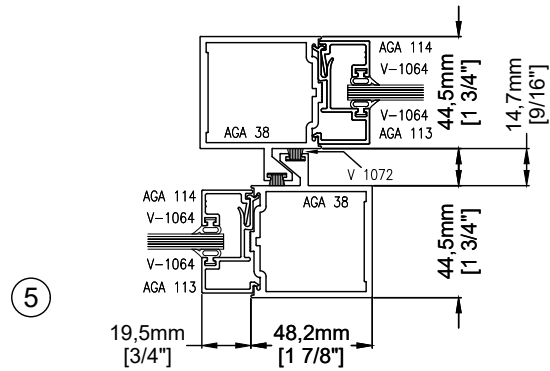
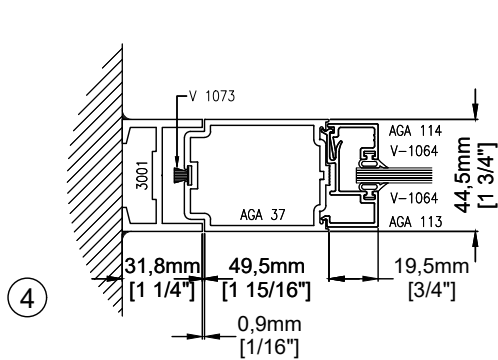
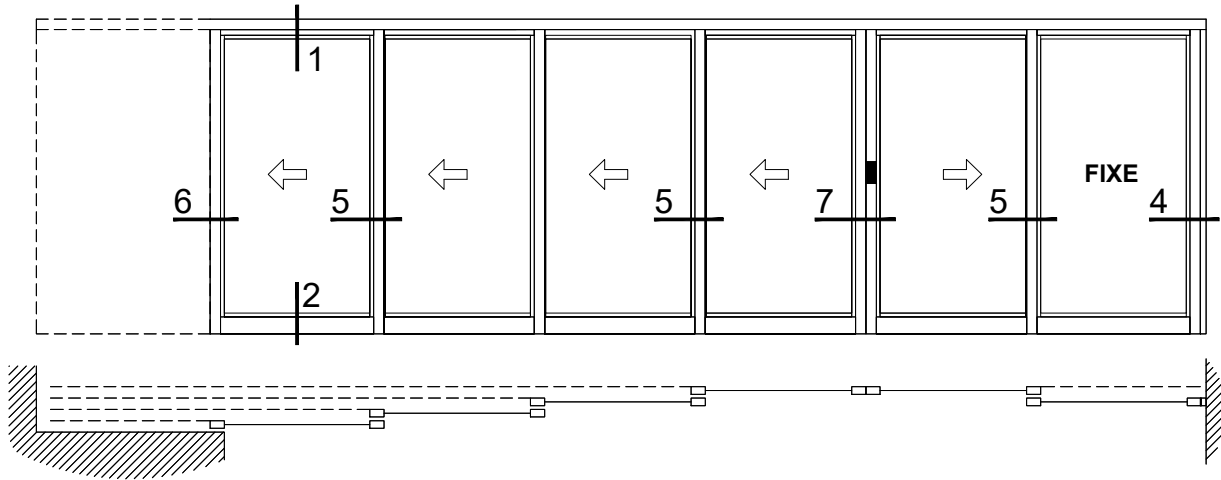

Options : Bases et Têtes / Bottom and Top rails

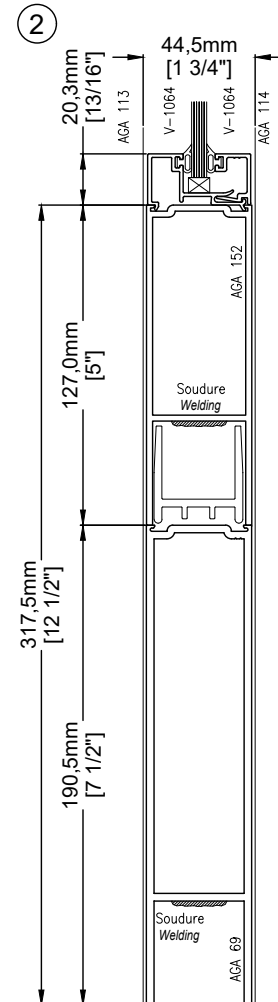
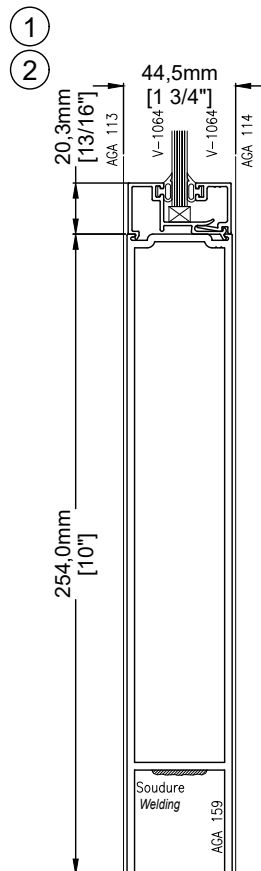
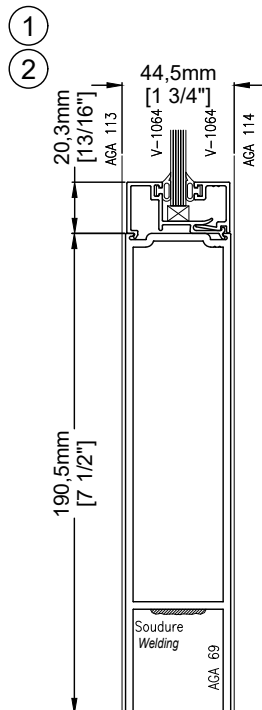
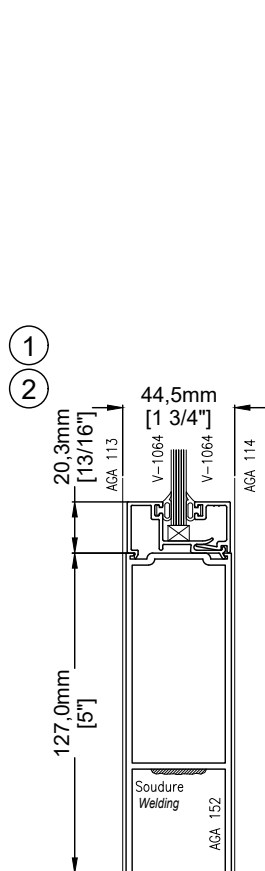
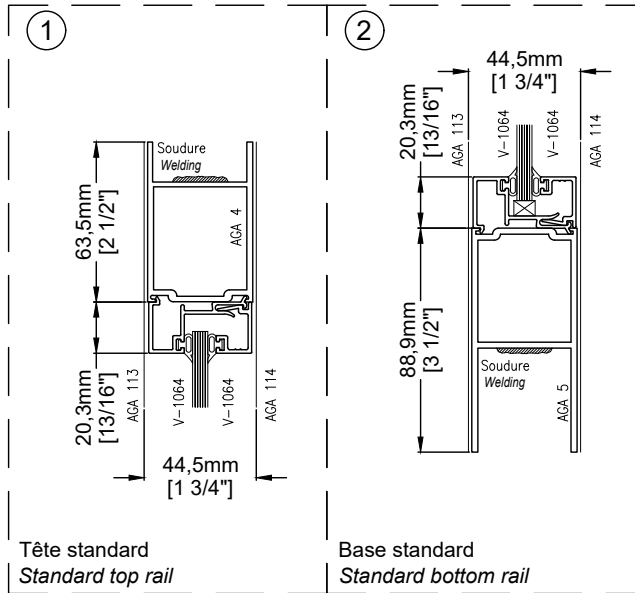
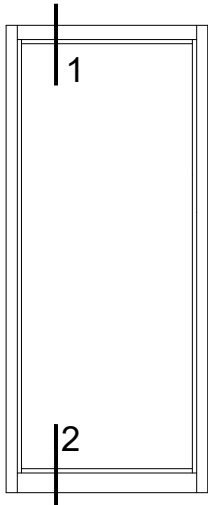

Options : Traverses / Mid rails

